

**WX RANGE**

**WX24
WX36
WX60
WX60F**

- NOTICE -

This Manual is prepared for the use of trained Hobart Service Technicians and should not be used by those not properly qualified.

This manual is not intended to be all encompassing. If you have not attended a Hobart Service School for this product, you should read, in its entirety, the repair procedure you wish to perform to determine if you have the necessary tools, instruments and skills required to perform the procedure. Procedures for which you do not have the necessary tools, instruments and skills should be performed by a trained Hobart Service Technician.

The reproduction, transfer, sale or other use of this manual, without the express written consent of Hobart, is prohibited.

This manual has been provided to you by ITW Food Equipment Group LLC ("ITW FEG") without charge and remains the property of ITW FEG, and by accepting this manual you agree that you will return it to ITW FEG promptly upon its request for such return at any time in the future.

TABLE OF CONTENTS

1. GENERAL	3
INTRODUCTION	3
SPECIFICATIONS	3
INSTALLATION, OPERATION AND CLEANING	3
TOOLS	3
LUBRICATION	3
2. REMOVAL AND REPLACEMENT PARTS	4
MANIFOLD COVER	4
KICK PANEL	4
STANDARD OVEN PILOT ASSEMBLY AND THERMOCOUPLE	4
STANDARD OVEN BURNER & ORIFICE HOOD	6
OVEN THERMOSTAT	7
TOP BURNER PILOT VALVE	8
TOP BURNER CONTROL VALVE	8
TOP BURNER ASSEMBLY	9
OVEN DOOR	10
DOOR STOP	13
GAS PRESSURE REGULATOR	13
GRIDDLE PILOT ASSEMBLY AND THERMOCOUPLE	14
GRIDDLE BURNER ORIFICE HOOD	15
3. SERVICE PROCEDURES, TEST AND ADJUSTMENTS	16
TOP BURNER PILOT ADJUSTMENT	16
BURNER AIR SHUTTER ADJUSTMENT	16
BURNER NOZZLE CHECK	16
OVEN THERMOSTAT BY-PASS FLAME ADJUSTMENT	16
OVEN THERMOSTAT TEMPERATURE CALIBRATION	17
THERMOCOUPLE TEST	18
OPERATION	18
PILOT CHECKS	18
THERMOCOUPLE CHECKS	18
4. FIRMWARE / SOFTWARE	20
FIRMWARE / SOFTWARE	20
5. PROGRAMMING	21
PROGRAMMING	21
6. ELECTRICAL OPERATION	22
COMPONENT LAYOUT AND FUNCTION	23
7. SEQUENCE OF OPERATION	25
SEQUENCE OF OPERATION	25
8. DIAGRAMS	26
DIAGRAMS	26
9. TROUBLESHOOTING	27
TROUBLESHOOTING	27

1. GENERAL

INTRODUCTION

This manual is applicable only to models listed on the cover page. Procedures in this manual will apply to all models unless specified. Pictures and illustrations can be of any model unless they need to be model specific.

SPECIFICATIONS

Model	Burners	Total Input BTU / HR
WX24-4BN	4	143,000
WX24-4BP	4	143,000
WX36-6BN	6	198,000
WX-36-BP	6	198,000
WX60F-6B2 4GN	6	268,000
WX60F-6B2 4GB	6	268,000
WX60-10BN	10	340,000
WX60-10BP	10	340,000

Gas Pressures

- Manifold/Operating Pressure
 - Natural: 5 in. W.C.
 - Propane: 10 in. W. C.

Inlet Supply Pressure

- Natural - Recommended 7 in. W. C.; Minimum 5 in. W. C.
- Propane - Recommended 11 in. W. C. ; Minimum 11 in. W. C.
- Maximum 14 in. W.C. (0.5 PSI) (Natural or Propane)

INSTALLATION, OPERATION AND CLEANING

For detailed installation, operation and cleaning instructions, refer to Instruction manual sent with each unit. The manual is also available online at www.vulcanequipment.com.

TOOLS

Standard

- Standard set of hand tools.

- VOM with measuring micro amp current tester. Any VOM with minimum of CAT III 600V, CE certified. Sensitivity of at least 20,000 ohms per volt can be used. In addition, meter leads must also be a minimum of CAT III 600V.
- Clamp on type amp meter with minimum of NFPA-70E CAT III 600V, UL/CSA/TUV listed.
- Temperature tester (K type thermocouple preferred).
- Manometer.

Special

- Loctite® 246™ for use on door handle mounting screws.
- 3/4" pipe tee and hose barb assembly for temporarily checking manifold pressure when a pressure tap is not available in the gas manifold on some models.
- Pipe taps may be needed to clean or repair internal threads on gas manifolds. Use a wire brush to clean external pipe threads on fittings.
- Adaptor to test thermocouple closed circuit DC voltages (purchase locally). Adaptors vary between manufacturers. Example of one adaptor type is in [Fig. 1](#).



Fig. 1

LUBRICATION

Anderson and Forrester (or comparable) valve grease for top burner gas valves, top burner pilot valves, and pressure tap plugs. Apply light coat to valve/plugs. Apply light coat to valve/plug threads, Valve grease must be insoluble in propane and natural gas.

2. REMOVAL AND REPLACEMENT PARTS

MANIFOLD COVER



WARNING

Shut off the gas before servicing the unit and follow lockout / tagout procedures.

1. Pull crumb tray out.



Fig. 2

2. Loosen set screws in top burner control knobs and remove knobs.

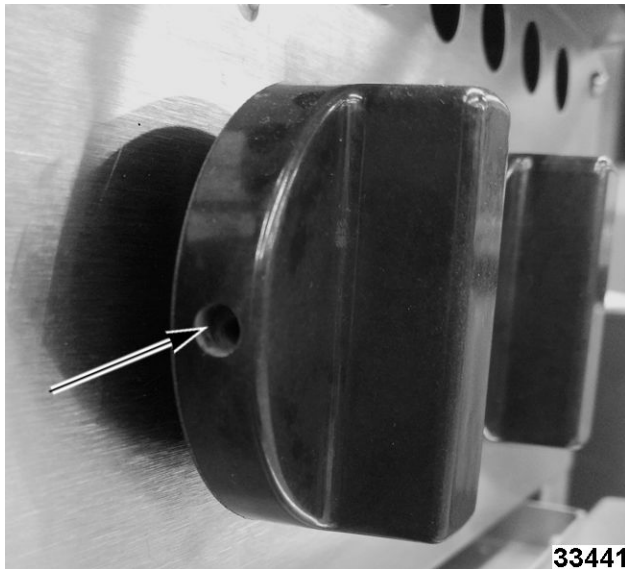

Fig. 3

3. Remove manifold mounting screws.



Fig. 4

4. Reverse procedure to install.

KICK PANEL



WARNING

Shut off the gas before servicing the unit and follow lockout / tagout procedures.

1. Lift up on kick panel and rotate down 90 degrees.
2. Remove kick panel mounting bracket.

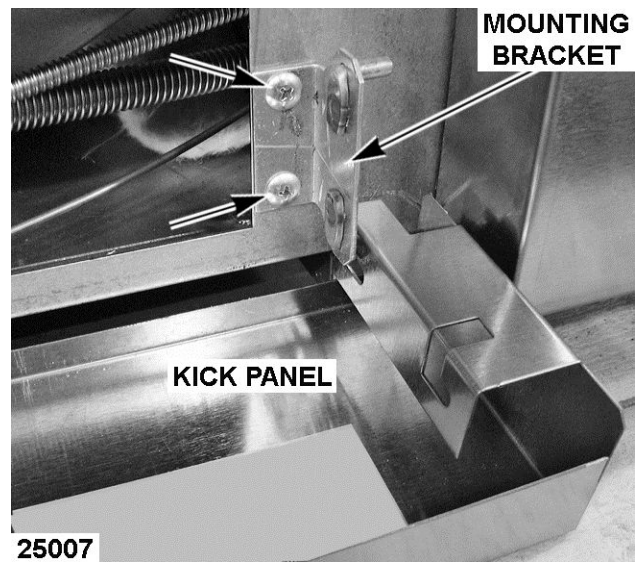

Fig. 5

3. Reverse procedure to install.

STANDARD OVEN PILOT ASSEMBLY AND THERMOCOUPLE



WARNING

Shut off the gas before servicing the unit and follow lockout / tagout procedures.

1. Remove oven racks. Lift up and pull out rack guides (1, Fig. 6).

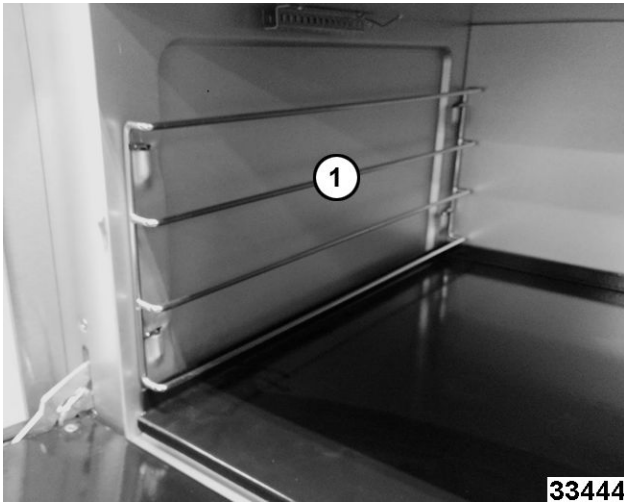

Fig. 6

2. Lift cavity bottom panel (1, Fig. 7) and slide out.

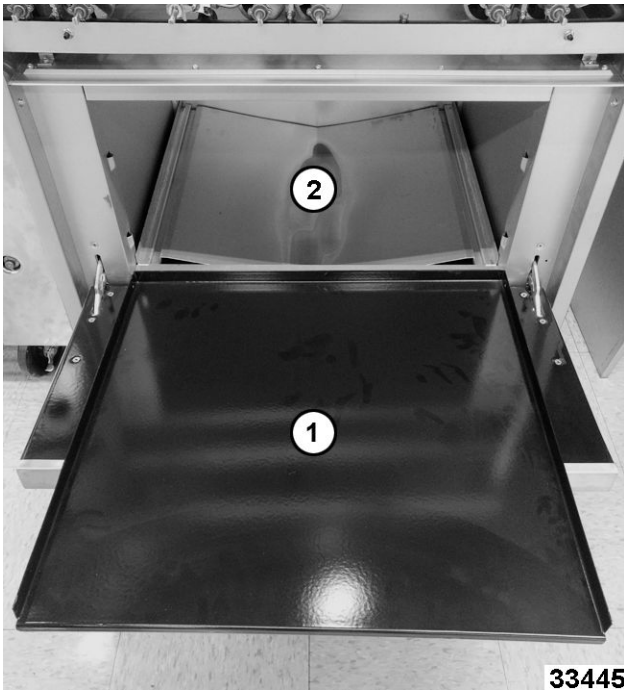

Fig. 7

3. Remove V baffle (2, Fig. 7).
4. Lower kick panel.



Fig. 8

5. Remove thermocouple nut (1, Fig. 9).

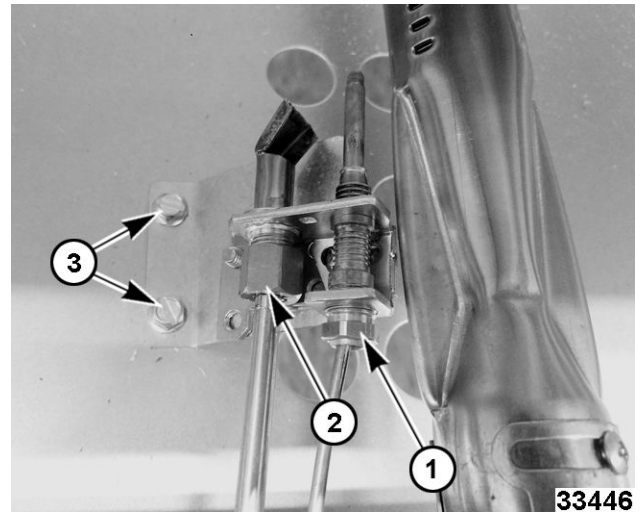

Fig. 9

6. Remove pilot nut (2, Fig. 9).

NOTE: Take care not to lose pilot orifice after removing nut.

7. Remove mounting bracket screws (3, Fig. 9) to remove pilot oven assembly.

NOTE: If replacing oven pilot assembly, remove pilot tubing and thermocouple from oven pilot assembly.

8. Reverse procedure to install.

NOTICE

When installing, do not bend and kink the capillary tube or damage to the component may occur.

WARNING

All gas joints disturbed during servicing must be checked for leaks. Check with a soap and water solution (bubbles). Do not use an open flame.

9. Verify operation.

STANDARD OVEN BURNER & ORIFICE HOOD



⚠ WARNING

Shut off the gas before servicing the unit and follow lockout / tagout procedures.

1. Remove oven racks. Lift up and pull out rack guides (1, Fig. 10).



Fig. 10

2. Lift cavity bottom panel (1, Fig. 11) and slide out.

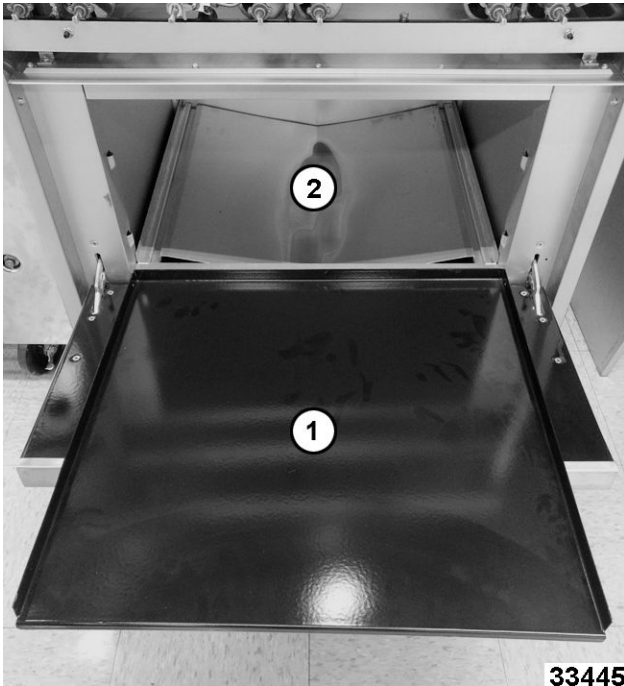

Fig. 11

3. Remove V baffle (2, Fig. 11).

4. Remove cotter pin.

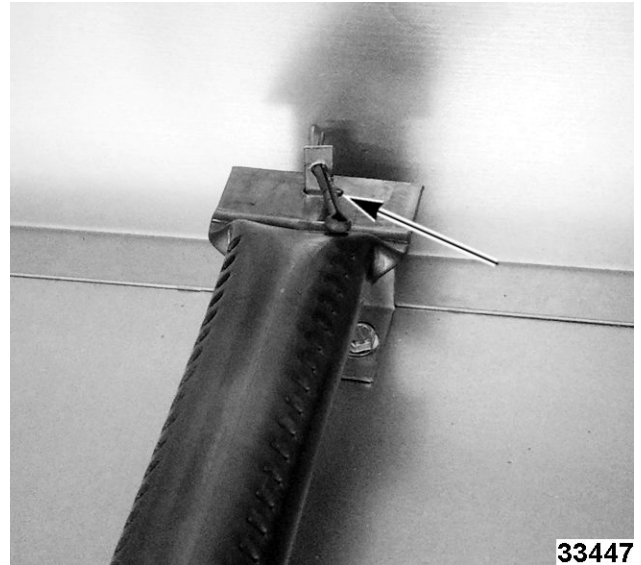

Fig. 12

5. Lift up back of burner (1, Fig. 13) and move burner toward rear of oven to disengage from burner orifice (2, Fig. 12).

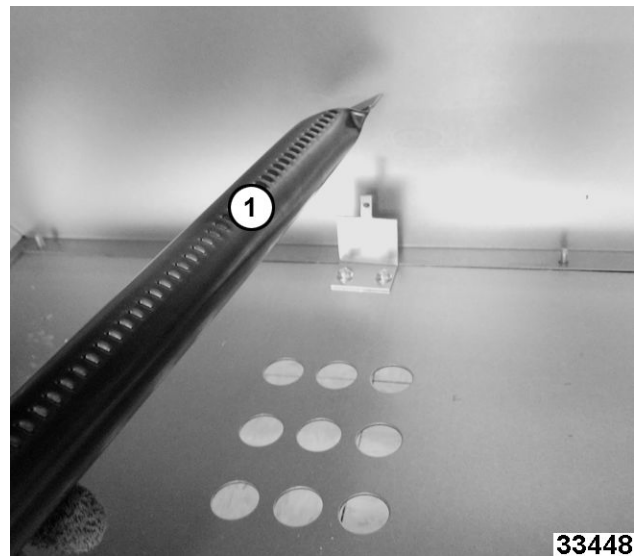

Fig. 13

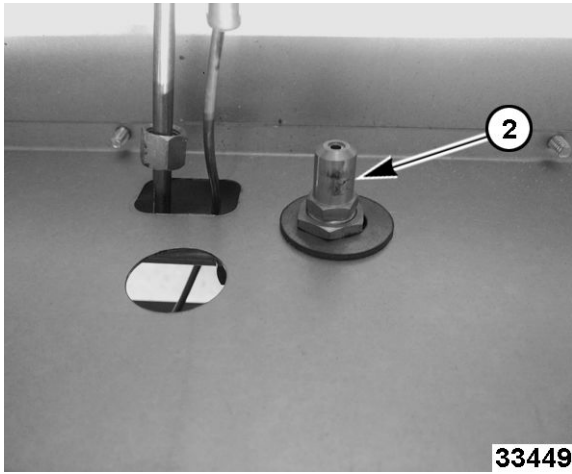

Fig. 14

6. If applicable, unscrew orifice hood mounting nut to remove orifice.
7. Reverse procedure to install.

⚠ WARNING

All gas joints disturbed during servicing must be checked for leaks. Check with a soap and water solution (bubbles). Do not use an open flame.

8. Verify proper operation.

OVEN THERMOSTAT



⚠ WARNING

Shut off the gas before servicing the unit and follow lockout / tagout procedures.

1. Remove oven racks. Lift up and pull out rack guides (1, Fig. 15).



Fig. 15

2. Remove capillary bulb cover.

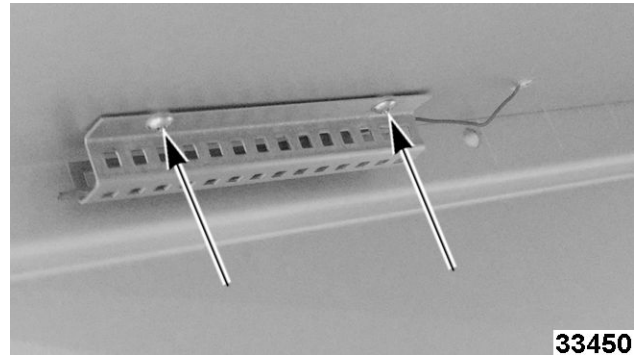

Fig. 16

3. Remove MANIFOLD COVER.
4. Remove burner grates (1, Step 4) as needed to access capillary tube.

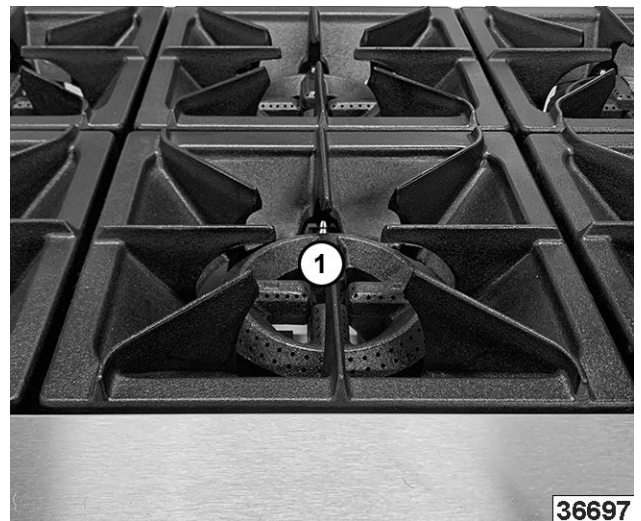

Fig. 17

5. Remove capillary tube clamp (1, Fig. 18).

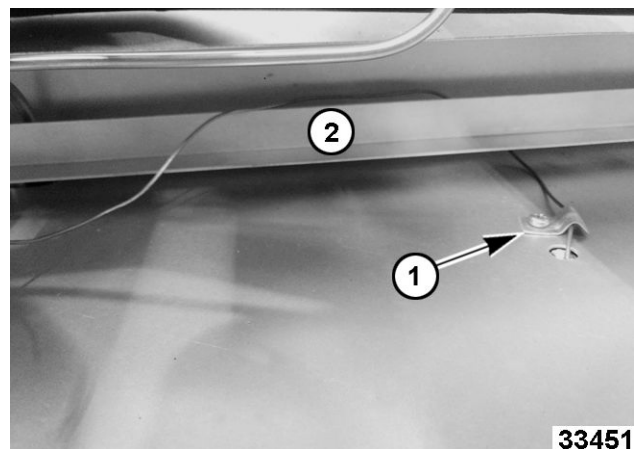

Fig. 18

6. Remove capillary tube from around guard (2, Fig. 18).
7. Roll capillary tube up.

NOTE: Rolling capillary tube up will allow clearance to turn/rotate thermostat valve assembly off manifold.

8. Disconnect thermostat valve assembly connections.
 - A. Gas outlet to burner (1, Fig. 19).
 - B. Thermocouple to oven burner. (2, Fig. 19)

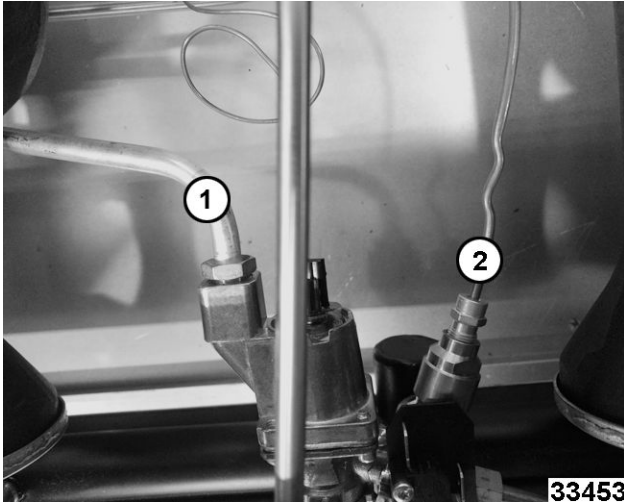

Fig. 19

9. Disconnect gas outlet to pilot (1, Fig. 20).

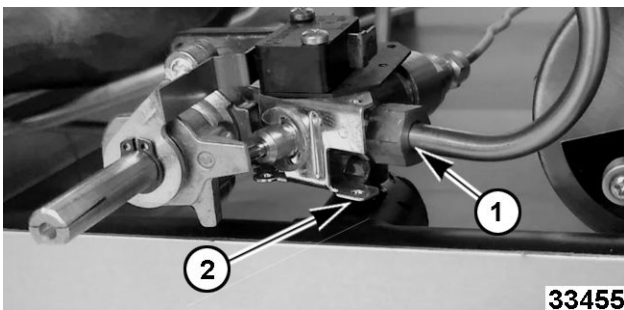

Fig. 20

10. Roll capillary tube up.
11. Unscrew thermostat valve assembly (2, Fig. 20) off manifold.

NOTE: Depending on range options, some will have additional valves on either side that may need removed for clearance to remove thermostat valve.

12. Reverse procedure to install.

⚠ WARNING

All gas joints disturbed during servicing must be checked for leaks. Check with a soap and water solution (bubbles). Do not use an open flame.

TOP BURNER PILOT VALVE



⚠ WARNING

Shut off the gas before servicing the unit and follow lockout / tagout procedures.

1. Remove MANIFOLD COVER.
2. Remove fitting (1, Fig. 21) securing pilot tube to pilot valve.

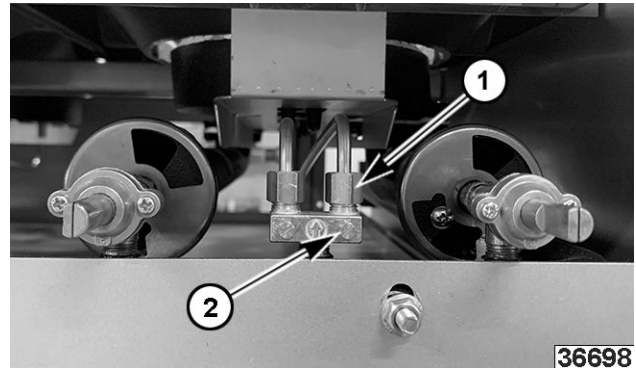

Fig. 21

3. Unscrew pilot valve (2, Fig. 21) from manifold.
4. Reverse procedure to install.

NOTICE

Do not over tighten pilot valve or damage to the threads may occur.

⚠ WARNING

All gas joints disturbed during servicing must be checked for leaks. Check with a soap and water solution (bubbles). Do not use an open flame.

TOP BURNER CONTROL VALVE



⚠ WARNING

Shut off the gas before servicing the unit and follow lockout / tagout procedures.

1. Remove MANIFOLD COVER.
2. Remove TOP BURNER ASSEMBLY.
3. Remove TOP BURNER PILOT VALVE.
4. Disconnect pilot tubing (1, Fig. 22) from thermostat assembly for clearance if needed.

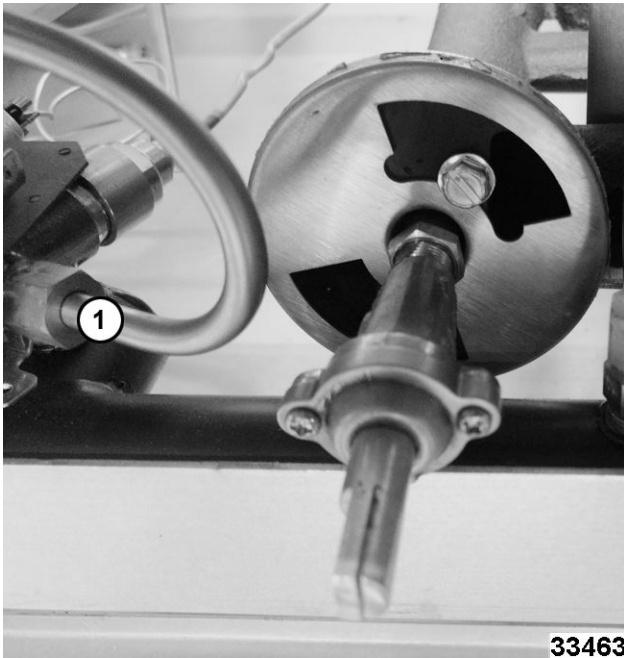

Fig. 22

- Remove top burner control valve (1, Fig. 23) from manifold.

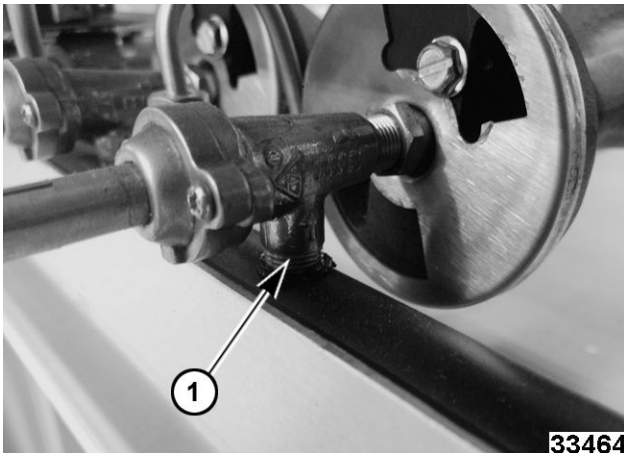

Fig. 23

NOTICE

Inspect top control valve for wear or damage and replace as necessary.

- Reverse procedure to install.

WARNING

All gas joints disturbed during servicing must be checked for leaks. Check with a soap and water solution (bubbles). Do not use an open flame.

NOTICE

Ensure top burner control valve is aligned and centered in the burner assembly opening. The valve must be perpendicular to the manifold.

- Verify proper operation.

TOP BURNER ASSEMBLY



WARNING

Shut off the gas before servicing the unit and follow lockout / tagout procedures.

- Remove burner grates (1, Fig. 24).

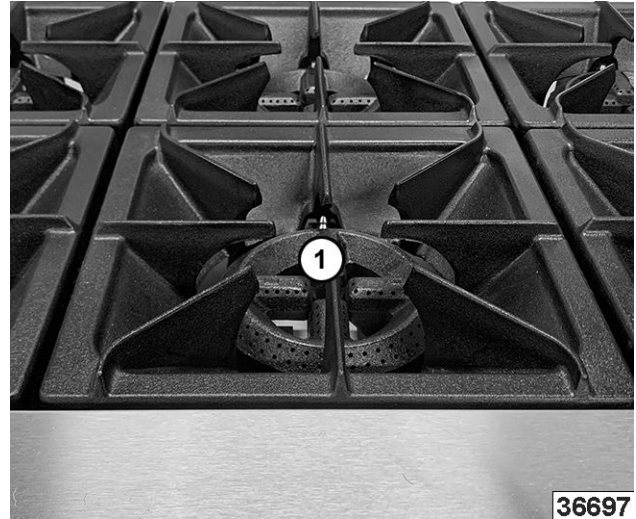

Fig. 24

- Remove center burner grate support.



Fig. 25

- Lift burner heads (1, Fig. 26) off.

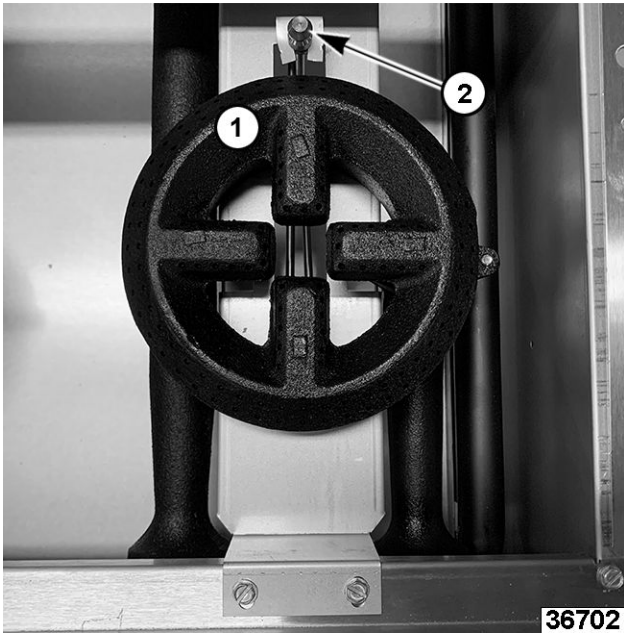

Fig. 26

4. Remove burner retainer bracket (2, Fig. 26).
5. Unclip pilot.

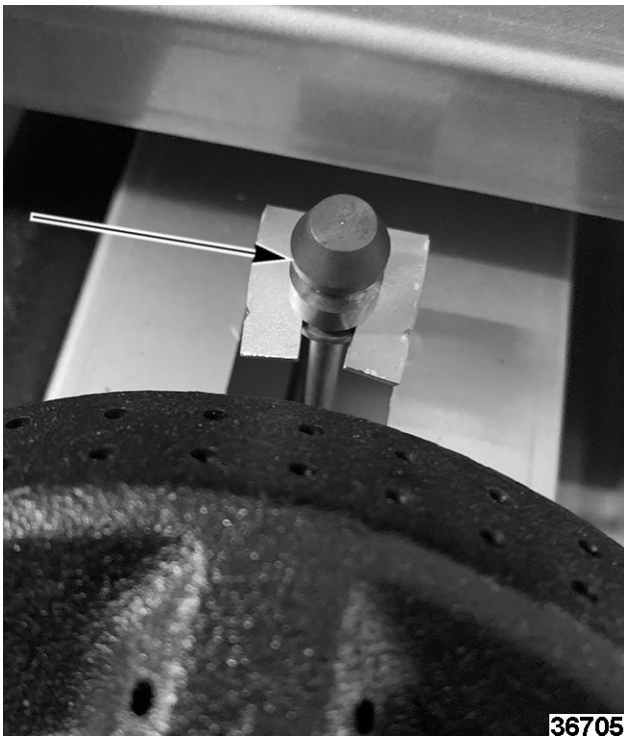

Fig. 27

6. Lift top burner assembly at the rear and pull away from front manual valves.



Fig. 28

7. Reverse procedure to install.

⚠ WARNING

All gas joints disturbed during servicing must be checked for leaks. Check with a soap and water solution (bubbles). Do not use an open flame.

8. Verify proper operation.
9. Verify BURNER AIR SHUTTER ADJUSTMENT.

OVEN DOOR

⚠ WARNING

When servicing hinges, use cut resistant glove with additional padding to compress hinge to insert bolt into slot or remove bolt after door is removed.



⚠ WARNING

Shut off the gas before servicing the unit and follow lockout / tagout procedures.

Remove Door

1. Lower kick panel (1, Fig. 29).



Fig. 29

2. Open door enough to move left and right safety latches from the disengaged position (Fig. 30) to the engaged position (Fig. 31).

⚠ WARNING

Hold both sides of door when engaging safety latches on the locking lever. After safety latches are in the engaged position, hold the door and do not open more angles. The safety latches will be crushed easily if any force pushes down the door at that moment.



Fig. 30



Fig. 31

3. Lift up on door, while holding both sides, to disengage locking lever notch (1, Fig. 32) on both sides.

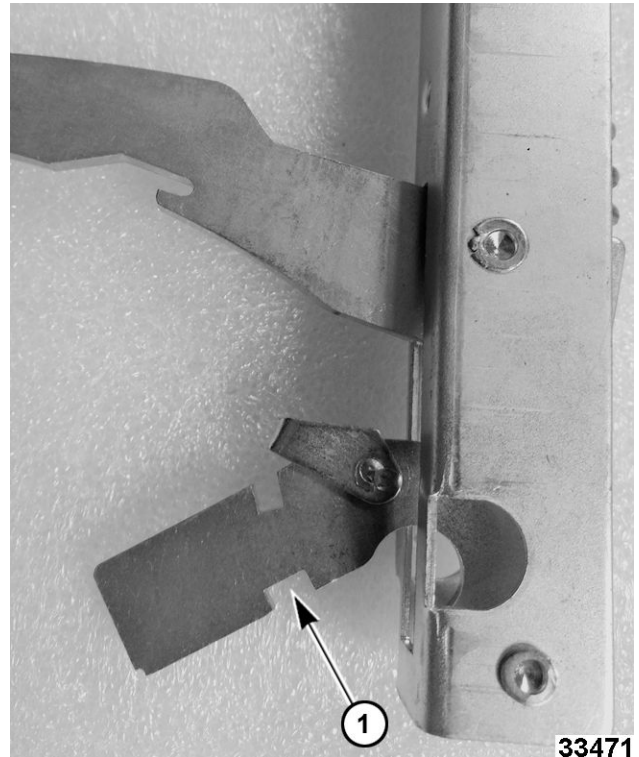

Fig. 32

- A. Release notch on the swivel hinge, from bottom edge of the door hinge stop to remove door.
- B. Release spring loaded hinge from the roller and pin inside the slot (Fig. 34) on door hinge stop to remove door.

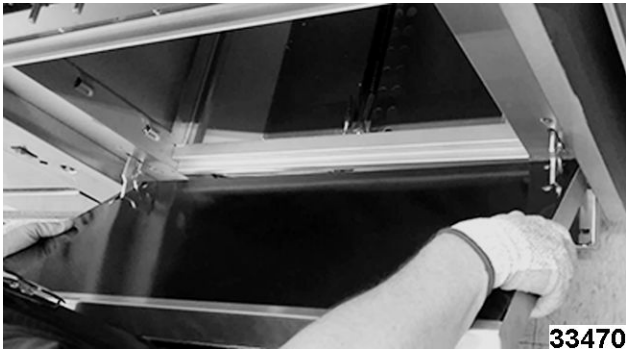

Fig. 33

NOTE: Fig. 34 shows bracket with pin and roller inside slot not mounted in oven frame for clarity.

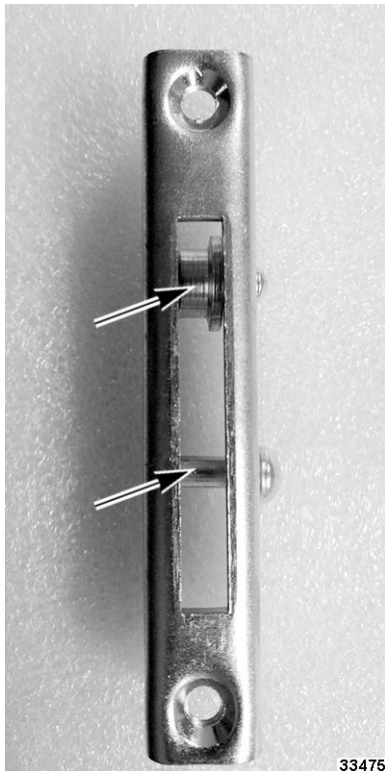

Fig. 34

Remove Hinge

1. Remove DOOR.
2. Stabilize door on floor.



Fig. 35

3. Press against spring loaded arm to release safety latch.



Fig. 36

4. Remove screws out of door hinges to separate door.
5. Remove inner door panel mounting screws and separate from door.

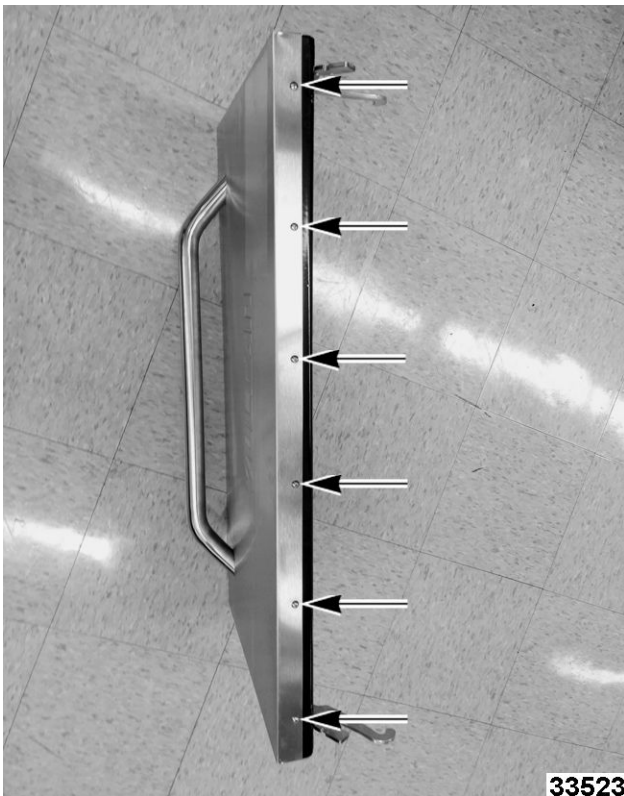

Fig. 37

6. Remove hinges.
7. Reverse procedure to install.

DOOR STOP



⚠ WARNING

Shut off the gas before servicing the unit and follow lockout / tagout procedures.

1. Remove OVEN DOOR.
2. Tie string or flexible wire around pin or roller (1, Fig. 38).

NOTE: Holding onto string/wire while removing stop will secure it from falling down into oven cavity.

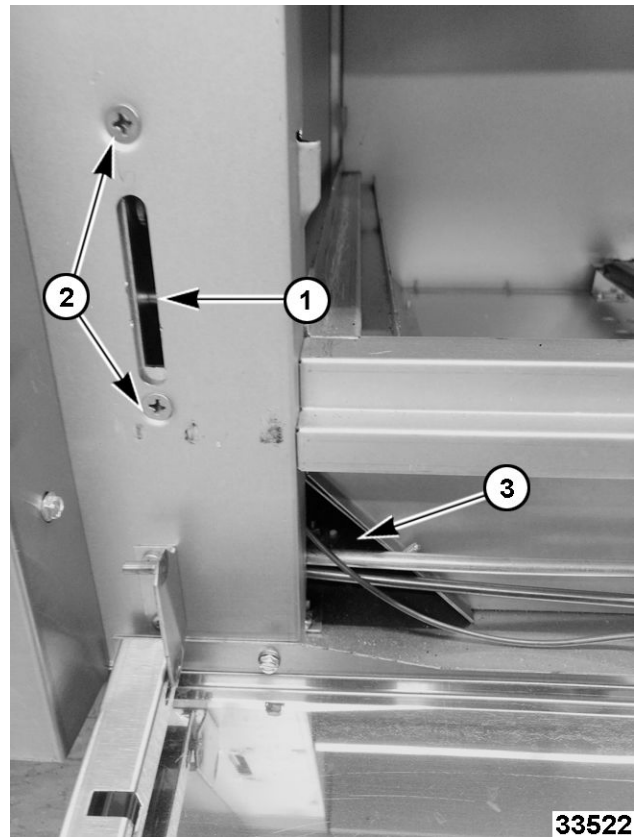

Fig. 38

3. Remove stop bracket from oven frame (2, Fig. 38).
4. Slide stop bracket down cavity channel and out through opening (3, Fig. 38).
5. Tie string or flexible wire around pin or roller on new bracket to assist installation up through cavity channel.
6. Align oven frame and stop bracket mounting holes and install screws.
7. Reverse procedure to install.
8. Verify door operation.

GAS PRESSURE REGULATOR



⚠ WARNING

Shut off the gas before servicing the unit and follow lockout / tagout procedures.

1. Access gas pressure regulator on back of range.
2. Remove regulator access cap.



Fig. 39

NOTICE

Regulator piston is installed in different directions for type of gas being used. Turn upside down to change directions. 1, in Fig. 40, shows direction for propane gas. 2, in Fig. 41 shows direction for natural gas.



Fig. 40

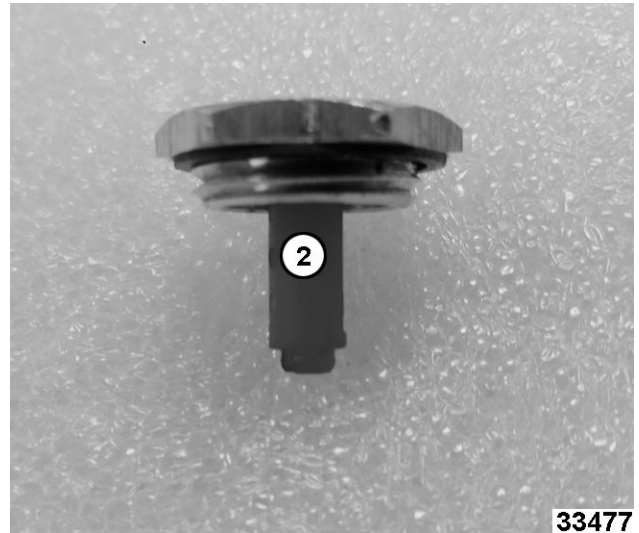

Fig. 41

3. Verify proper operation.

WARNING

All gas joints disturbed during servicing must be checked for leaks. Check with a soap and water solution (bubbles). Do not use an open flame.

GRIDDLE PILOT ASSEMBLY AND THERMOCOUPLE



WARNING

Shut off the gas before servicing the unit and follow lockout / tagout procedures.

1. Remove MANIFOLD COVER.
2. Remove pilot assembly mounting bracket to griddle burner box.
3. Remove pilot assembly mounting screws to bracket.
4. If replacing pilot assembly, remove pilot tubing and thermocouple from pilot assembly.
5. Reverse procedure to install.

NOTICE

Do not bend or kink capillary tube.

NOTICE

Verify orifice hood is aligned and centered with burner assembly opening.

GRIDDLE BURNER ORIFICE HOOD



WARNING

Shut off the gas before servicing the unit and follow lockout / tagout procedures.

1. Remove MANIFOLD COVER.
2. Remove orifice hood from fitting.
3. Reverse procedure to install.

NOTICE

Verify orifice hood is aligned and centered with burner assembly opening.

3. SERVICE PROCEDURES, TEST AND ADJUSTMENTS

TOP BURNER PILOT ADJUSTMENT

1. Locate pilot adjustment screw (1, Fig. 42) through the access hole in manifold cover (1, Fig. 43).
 - Rotate clockwise to decrease flame height.
 - Rotate counterclockwise to increase flame height.

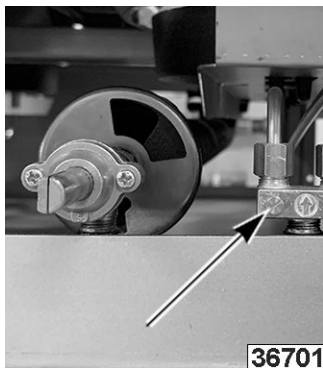

Fig. 42

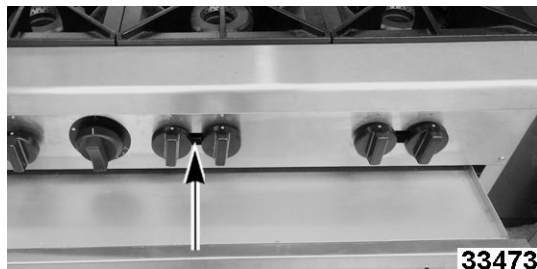

Fig. 43

NOTICE

On range models with a thermocouple, the pilot burner flame should surround and cover an area of at least 3/8" to 1/2" of the thermocouple at the hot tip end.

BURNER AIR SHUTTER ADJUSTMENT

The efficiency of the burner depends on a delicate balance between the air supply and volume of gas. Whenever this balance is disturbed, poor operating characteristics and excessive gas consumption may occur. An air shutter on the front of the burner controls the gas mixer balance.

- Proper flame should be blue in color, well-defined and seated on the burner port.

- Yellow flame is indication of insufficient primary air.
 - White-blue flame is a result of excessive primary air.
1. Loosen shutter screw.

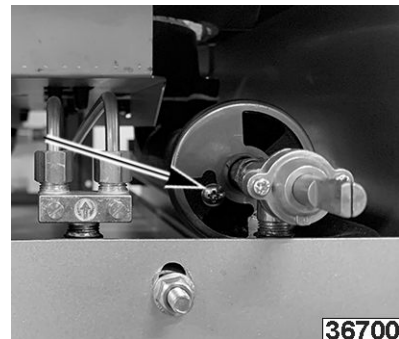

Fig. 44

2. Rotate air shutter open until flame begins to lift from burner.
3. Close the shutter slightly and tighten shutter screw.

NOTE: The factory default air shutter positions are half open natural; full open propane.

BURNER NOZZLE CHECK

NOTE: The burner nozzle is mounted between the oven gas supply tubing/mounting bracket and the u-burner assembly. If burner operation seems poor and other systems have been checked, access the burner for the range section being serviced and remove the burner nozzle.

1. Check for blockage or damage.
2. Verify gas orifice hood is correct for the altitude.

OVEN THERMOSTAT BY-PASS FLAME ADJUSTMENT

NOTE: The bypass flame setting has a direct affect on calibration, and must be verified prior to checking or adjusting calibration of any "modulating thermostat". The by-pass flame can be viewed through the kick panel for adjustment.

NOTICE

All burners on the device must be on during by-pass flame adjustment.

1. Turn thermostat knob to 375°F.
2. Wait 15 minutes for oven to heat up.
3. Turn thermostat knob to lowest oven setting. **DO NOT TURN OFF.**
4. Observe burner flame. The flame should be approximately 1/8" and stable on each port.

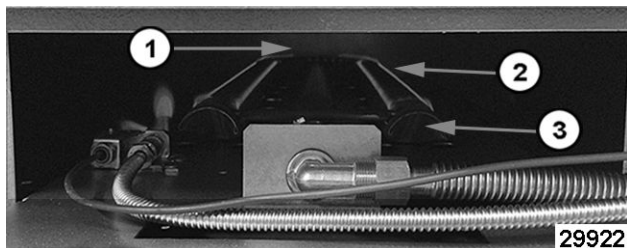

Fig. 45

By-Pass Flame Shown in Fig. 45	
Item	Description
1	Gap in flame, or some flickering to the flame is acceptable, only in the U-shape bend of the burner.
2	By-Pass flame.
3	Oven burner.

5. Remove thermostat knob.
6. Adjust by-pass flame.

NOTE: With small flat edge screwdriver, turn by-pass flame adjustment screw (1, Fig. 46) or ports should be set to just above “flickering”.

- Counterclockwise to increase by-pass flame.
- Clockwise to decrease flame.

NOTICE

Both legs of burner should have approximately 1/8" stable flame on each port.

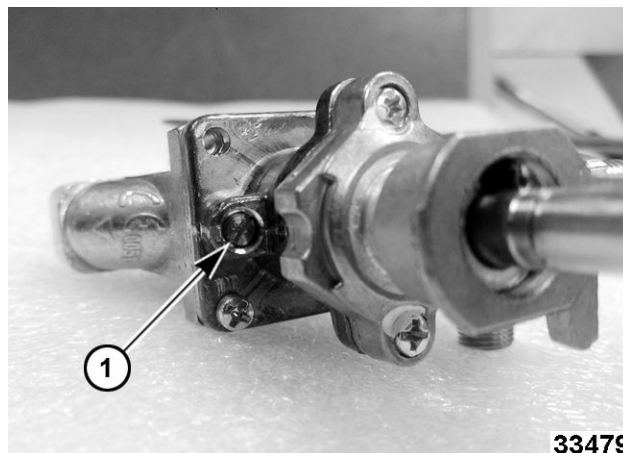

Fig. 46

7. Replace thermostat knob.
8. Turn knob to 400°. Verify increase in flame height on burner ports.
9. Turn knob back to lowest oven setting. Verify decrease in by-pass flame height on burner ports and that burner remains lit.
10. Verify OVEN THERMOSTAT TEMPERATURE CALIBRATION.

OVEN THERMOSTAT TEMPERATURE CALIBRATION



NOTE: Video available for Oven Thermostat Temperature Adjustment.

1. Pull oven temperature knob off.
2. Separate the knob from the stem.
3. Check oven temperature using temperature tester. Refer to: TOOLS.
4. Rotate knob left or right to temperature test reading and slide onto stem.

NOTE: If needed, loosen dial screws, rotate the dial to match temperature test reading and tighten screws.

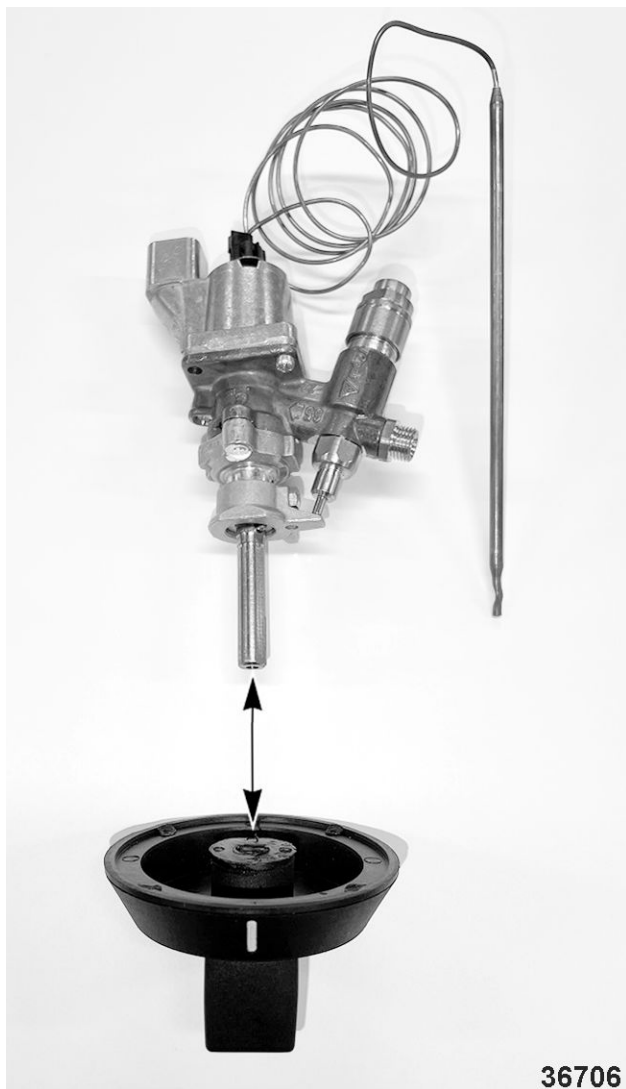

Fig. 48

NOTE: Current production thermostat assembly (Fig. 48) shown not assembled to oven for clarity.

NOTICE

Verify flats on knob and stem align.

THERMOCOUPLE TEST

Operation

The thermocouple supplies a DC millivolt signal (MV) to gas safety valve when heated by pilot flame. The gas safety valve will shut off gas flow to pilot and main burner in case of a pilot outage. When energized by thermocouple voltage, the gas safety valve is held open to permit gas flow to pilot and provide gas for burner when thermostat calls for heat. Height of pilot flame is controlled by an adjustable needle valve located under a small cover screw on the gas safety valve.

Pilot Checks

If experiencing pilot outages, perform the following:

Visually check pilot flame for the proper contact on thermocouple and adjust STANDARD OVEN PILOT ASSEMBLY AND THERMOCOUPLE. If adjustment does not result in a pilot flame of proper height, then gas might not be flowing properly to the pilot.

Check for:

- A plugged pilot orifice.
- Kinked or plugged pilot gas tubing.
- Low gas supply pressure.

Thermocouple Checks

NOTE: Tubing connection from the thermocouple tip to gas safety valve is an electrical connection and must be clean and dry. Do not use any sealing compound on the threads of thermocouple nut.

NOTICE

Do not overtighten the thermocouple nut or the insulator could be crushed, shorting the thermocouple. Finger tighten the nut plus 1/4 turn with a wrench only.

If pilot flame is correct and there are no excessive air drafts in the room, then problem is either the thermocouple output voltage or the gas safety valve.

Visually check the thermocouple tip (hot end) and tube lead for:

- Loose thermocouple connection (electrical) at the safety valve.
- Corrosion or debris on the threaded connector or thermocouple tip causing a poor electrical connection.
- Kinks or pinches that might cause a short between the tube and the wire inside.

If thermocouple is loose, tighten mounting nut.

NOTICE

Do not overtighten the thermocouple nut or the insulator could be crushed, shorting the thermocouple. Finger tighten the nut plus 1/4 turn with a wrench only.

If thermocouple connection shows signs of corrosion or debris that cannot be cleaned; or damage as described, replace it and check pilot operation. Refer to STANDARD OVEN PILOT ASSEMBLY AND THERMOCOUPLE.

Thermocouple Test

Check the thermocouple output voltage (DC millivolts) with a VOM as outlined in the steps below.

- If thermocouple adaptor (see TOOLS) is available, check *closed* circuit voltage as outlined in the test procedure.
 - If thermocouple adaptor is not available, check *open* circuit voltage as outlined in the test procedure.
 - If a VOM is not available, replace the thermocouple with a new one as outlined under the appropriate procedure below and check operation. Refer to STANDARD OVEN PILOT ASSEMBLY AND THERMOCOUPLE
1. Disconnect thermocouple from gas safety valve.
 2. Select the test to perform.
 3. **Closed Circuit.**
 - A. Install thermocouple adaptor at the threaded connection on gas safety valve.
 - B. Install thermocouple to the adaptor.

If a VOM is not available, replace the thermocouple with a new one as outlined under the appropriate procedure below and check operation.

- STANDARD OVEN PILOT ASSEMBLY AND THERMOCOUPLE

6. Check for proper operation.

NOTICE

Do not overtighten the thermocouple nut or the insulator could be crushed, shorting the thermocouple. Finger tighten the nut plus 1/4 turn with a wrench only.

- C. Light the pilot. Allow pilot to heat thermocouple for one to two minutes.
 - D. Connect one meter lead to the adaptor test point and the other meter lead to the tube. Compare reading to the value listed in the table below.
4. **Open Circuit.**
 - A. Connect one meter lead to the tip of the threaded end and the other meter lead to the tube. Compare reading to the values listed in the table below.
 - B. Light the pilot and continue to hold down the pilot gas button on the safety valve during this test. Allow pilot to heat thermocouple for one to two minutes.
 - C. Compare reading to the value listed in the table below.

THERMOCOUPLE MV READINGS		
	Closed Circuit	Open Circuit
Range	8 to 25 MV	25 to 35 MV

5. If readings are less than the minimum stated above, replace the thermocouple as outlined under the appropriate procedure below and check for proper operation.

4. FIRMWARE / SOFTWARE

FIRMWARE / SOFTWARE

Not applicable to this machine.

5. PROGRAMMING

PROGRAMMING

Not applicable to this machine.

6. ELECTRICAL OPERATION

COMPONENT LAYOUT AND FUNCTION

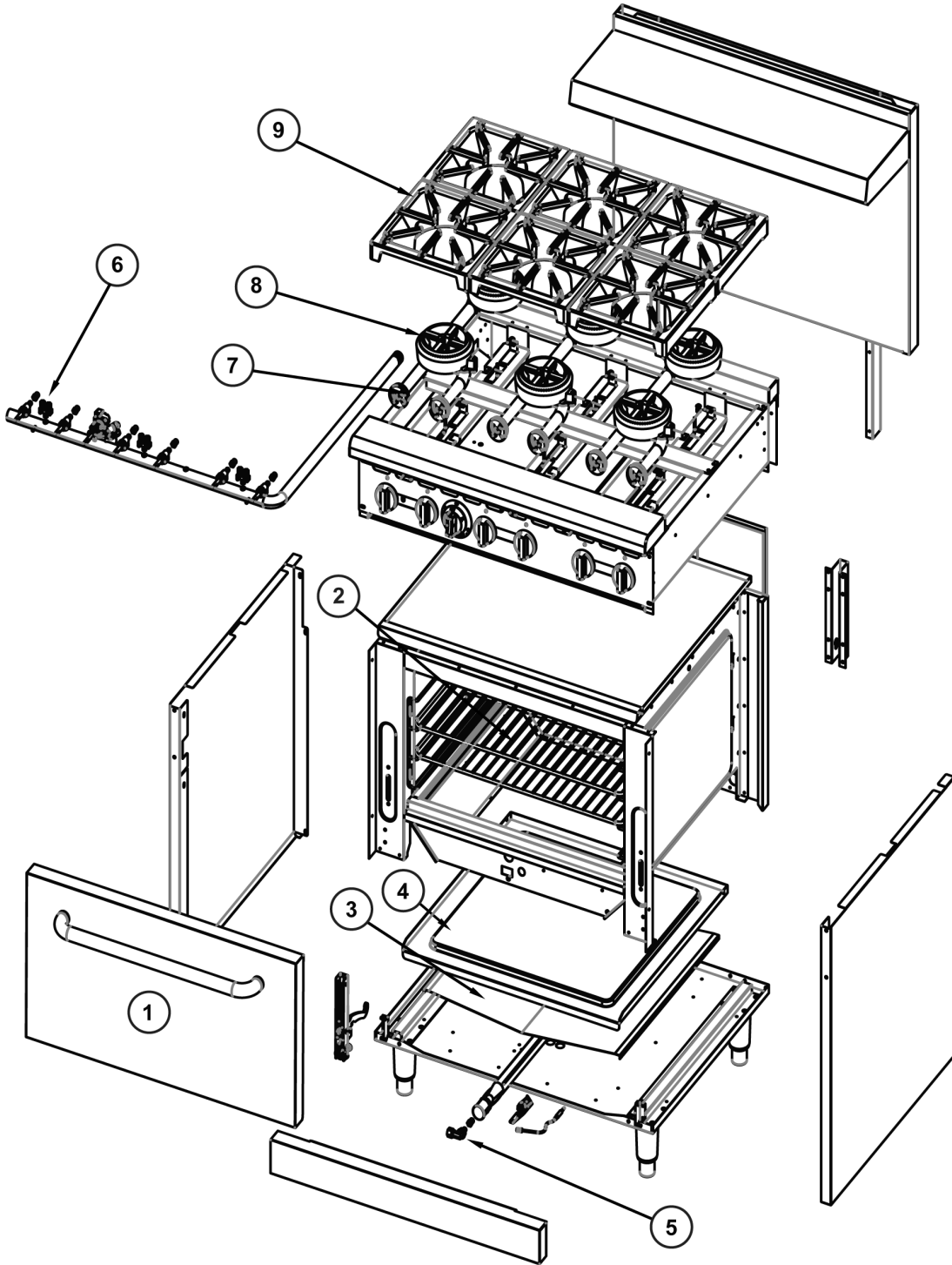

AI5537

Fig. 49

Item	Description
1	Door
2	Rack
3	V Baffle
4	Cavity Bottom Panel
5	Oven Pilot Assembly and Thermocouple
6	Manifold
7	Top Burner Valve Assembly
8	Burner
9	Grates

Burner Valve Allows the flow of gas to the pilot light and burner.

Open Top Pilot Small flame kept burning continuously to light range top burner.

Oven Pilot (Natural Gas or Propane) Small flame kept burning continuously to light oven burner.

Thermostat Combo Valve Flow control device to control the flow of gas to the oven with safety valve.

Thermocouple Provides milli-voltage signal to thermostat combo valve when heated by pilot flame.

7. SEQUENCE OF OPERATION

SEQUENCE OF OPERATION

Not applicable to this machine.

8. DIAGRAMS

DIAGRAMS

Not applicable to this machine.

9. TROUBLESHOOTING

TROUBLESHOOTING

GENERAL	
SYMPTOM	POSSIBLE CAUSE
Oven does not remain lit.	<ol style="list-style-type: none"> 1. Incorrect gas pressure. 2. Pilot burner not adjusted properly. 3. Pilot burner blocked. 4. Thermocouple not positioned correctly or malfunctioning. 5. Combination thermostat/safety valve malfunction. 6. Incorrect oven pilot orifice. 7. Ventilation issue in room (drafts blowing out pilot). 8. Defective burner, based on age of unit.
Pilot not lighting.	<ol style="list-style-type: none"> 1. Gas supply is off. 2. Additional time needed to bleed air out of gas line. 3. Low gas pressure. 4. Pilot burner not adjusted properly. 5. Incorrect oven pilot orifice.
Burner flame too yellow	<ol style="list-style-type: none"> 1. Orifice incorrect size or dirty. 2. Air shutter not adjusted correctly or dirty. 3. Incorrect gas pressure. 4. Incorrect gas type. 5. Orifice misaligned in venturi. 6. Appliance not venting properly.
Slow to heat or not hot enough.	<ol style="list-style-type: none"> 1. Low gas pressure. 2. Thermostat out of calibration.
Oven temperature too hot.	<ol style="list-style-type: none"> 1. Thermostat out of calibration. 2. By-pass flame to high.
Low burner flame (all burners).	<ol style="list-style-type: none"> 1. Low gas pressure. 2. Incorrect gas type.
Low burner flame (individual burner).	<ol style="list-style-type: none"> 1. Air mixture incorrect.
Flame floats on burner.	<ol style="list-style-type: none"> 1. Inadequate air supply. 2. Restricted exhaust flue (ovens).